

T110, Tantalum, MnO2 Tantalum, Commercial Grade, 1 uF, 10%, 50 VDC, 8 Ohms

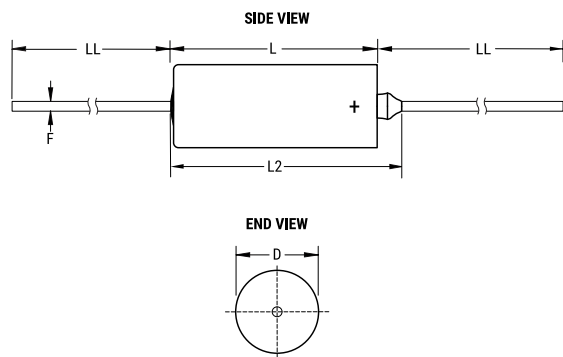

Dimensions	
D	3.43mm +/-0.25mm
L	7.26mm +/-0.79mm
L2	10.72mm
LL	38.1mm +/-6.35mm
F	0.51mm +/-0.05mm

Packaging Specifications	
Packaging:	Bulk, Box
Packaging Quantity:	150

General Information	
Series:	T110
Dielectric:	MnO2 Tantalum
Style:	Axial Hermetic
Description:	Axial, Solid Tantalum, Hermetically Sealed, Military (Non-ER), Polar
Features:	Polar
RoHS:	Yes
Termination:	Tin
Lead:	Wire Leads
AEC-Q200:	No
Construction:	Hermetic
Notes:	Dimensions Include Insulation Sleeve. When Supplied On T&R Or Ammo, Lead Length Is Determined By Taping Specification

Specifications	
Capacitance:	1 uF
Capacitance Tolerance:	10%
Voltage DC:	50 VDC (85C), 40 VDC (125C Surge), 0.5 VDC (125C Reverse)
Temperature Range:	-55/+125°C
Rated Temperature:	85°C
Dissipation Factor:	2%
Resistance:	8 Ohms (100kHz)
Leakage Current:	0.3 uA (25°C)

Statements of suitability for certain applications are based on our knowledge of typical operating conditions for such applications, but are not intended to constitute - and we specifically disclaim - any warranty concerning suitability for a specific customer application or use. This Information is intended for use only by customers who have the requisite experience and capability to determine the correct products for their application. Any technical advice inferred from this Information or otherwise provided by us with reference to the use of our products is given gratis, and we assume no obligation or liability for the advice given or results obtained.