

**KEMET Part Number: SSR21NVS-M15164**  
(UALS21V1516400)

**KEMET**

a YAGEO company

KEMET, SSR21NVS-M/NHS-M, AC Line Filters, Common Mode, 16.4 mH

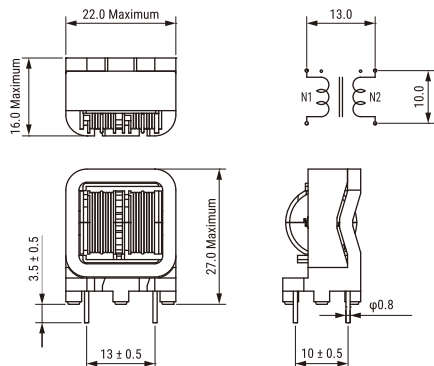

#### Dimensions

<b>L</b>	22mm MAX
<b>T</b>	16mm MAX
<b>H</b>	27mm MAX
<b>LL</b>	3.5mm +/-0.5mm
<b>S</b>	13mm +/-0.5mm
<b>S1</b>	10mm +/-0.5mm

#### Packaging Specifications

<b>Packaging:</b>	Tray
<b>Packaging Quantity:</b>	450
<b>Weight:</b>	14.5 g

#### General Information

<b>Series:</b>	SSR21NVS-M/NHS-M
<b>Style:</b>	Through-Hole
<b>Features:</b>	High Performance, High Impedance, Strong Inductance
<b>RoHS:</b>	Yes
<b>Miscellaneous:</b>	60 (K) Temperature Rise Max.

#### Specifications

<b>Voltage AC:</b>	250 VAC
<b>Inductance:</b>	16.4 mH (10 kHz)
<b>Current:</b>	1.5 A
<b>Temperature Range:</b>	-25/+120°C
<b>DC Resistance:</b>	230 mOhms

Statements of suitability for certain applications are based on our knowledge of typical operating conditions for such applications, but are not intended to constitute - and we specifically disclaim - any warranty concerning suitability for a specific customer application or use. This Information is intended for use only by customers who have the requisite experience and capability to determine the correct products for their application. Any technical advice inferred from this Information or otherwise provided by us with reference to the use of our products is given gratis, and we assume no obligation or liability for the advice given or results obtained.

**KEMET**

a YAGEO company