

KEMET Part Number: SSR21NVS-M031500
(UALS21V0315000)

KEMET

a YAGEO company

KEMET, SSR21NVS-M/NHS-M, AC Line Filters, Common Mode, 150 mH

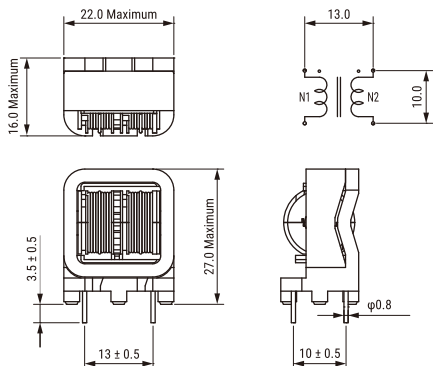

Dimensions

L	22mm MAX
T	16mm MAX
H	27mm MAX
LL	3.5mm +/-0.5mm
S	13mm +/-0.5mm
S1	10mm +/-0.5mm

Packaging Specifications

Packaging:	Tray
Packaging Quantity:	450
Weight:	14.5 g

General Information

Series:	SSR21NVS-M/NHS-M
Style:	Through-Hole
Features:	High Performance, High Impedance, Strong Inductance
RoHS:	Yes
Miscellaneous:	40 (K) Temperature Rise Max.

Specifications

Voltage AC:	250 VAC
Inductance:	150 mH (10 kHz)
Current:	300 mA
Temperature Range:	-25/+120°C
DC Resistance:	2.7 Ohms

Statements of suitability for certain applications are based on our knowledge of typical operating conditions for such applications, but are not intended to constitute - and we specifically disclaim - any warranty concerning suitability for a specific customer application or use. This Information is intended for use only by customers who have the requisite experience and capability to determine the correct products for their application. Any technical advice inferred from this Information or otherwise provided by us with reference to the use of our products is given gratis, and we assume no obligation or liability for the advice given or results obtained.

KEMET

a YAGEO company