

**KEMET Part Number: L1210R330KDWIT**  
(L1210R330KDWIT)

**KEMET**

a YAGEO company

KEMET, L-DWI, Power, 33 uH, 10%

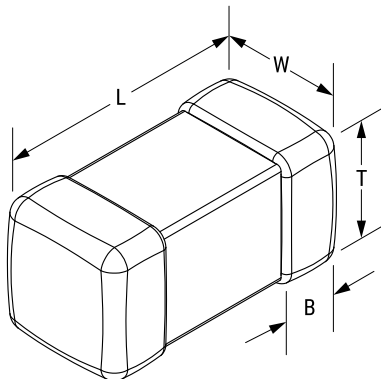

Dimensions	
Chip Size	1210
L	3.2mm +/-0.2mm
W	2.5mm +/-0.2mm
T	2.5mm +/-0.2mm
LL	0.6mm +/-0.3mm
B	0.6mm +/-0.3mm

Packaging Specifications	
Packaging:	T&R
Packaging Quantity:	1000

General Information	
Series:	L-DWI
Style:	SMD Chip
Description:	Surface Mount Inductor
Features:	High Current Type
RoHS:	Yes

Specifications	
Inductance:	33 uH (0.1 MHz)
Inductance Tolerance:	10%
Temperature Range:	-40/+105°C
Current:	500 mAmps (Isat, 30% Drop In Inductance), 570 mAmps (Irms, 40C Rise By Self Heating)
DC Resistance:	0.41 Ohms
Self-Resonant Frequency:	13 MHz

Statements of suitability for certain applications are based on our knowledge of typical operating conditions for such applications, but are not intended to constitute - and we specifically disclaim - any warranty concerning suitability for a specific customer application or use. This Information is intended for use only by customers who have the requisite experience and capability to determine the correct products for their application. Any technical advice inferred from this Information or otherwise provided by us with reference to the use of our products is given gratis, and we assume no obligation or liability for the advice given or results obtained.

**KEMET**

a YAGEO company