

KEMET Part Number: HHBC10-0R8A0068V
(UALC100R8A0068)

KEMET
a YAGEO company

KEMET, HHBC, AC Line Filters, Normal Mode, 0.068 mH, 20%

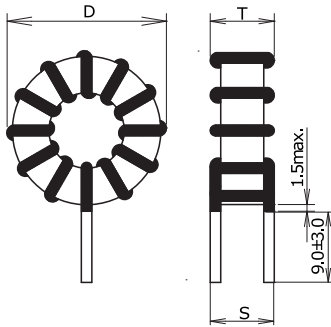

Dimensions	
D	21.5mm MAX
T	12.3mm MAX
LL	9mm +/-3mm
S	8mm NOM

Packaging Specifications	
Packaging:	Tray
Packaging Quantity:	240
Weight:	10 g

General Information	
Series:	HHBC
Style:	Through-Hole
Features:	Noise Solution, Switching Power Supply Outlets, DC-DC Converter
RoHS:	Yes
Miscellaneous:	20 (K) Temperature Rise Max.

Specifications	
Inductance:	68 uH
Inductance Tolerance:	20%
Current:	3 A
Temperature Range:	-40/+125°C
DC Resistance:	42.3 mOhms

Statements of suitability for certain applications are based on our knowledge of typical operating conditions for such applications, but are not intended to constitute - and we specifically disclaim - any warranty concerning suitability for a specific customer application or use. This Information is intended for use only by customers who have the requisite experience and capability to determine the correct products for their application. Any technical advice inferred from this Information or otherwise provided by us with reference to the use of our products is given gratis, and we assume no obligation or liability for the advice given or results obtained.

KEMET
a YAGEO company