

KEMET, GL, EMI/RFI Filters, Noise Suppression, 250 VAC, 250 V, 6 A

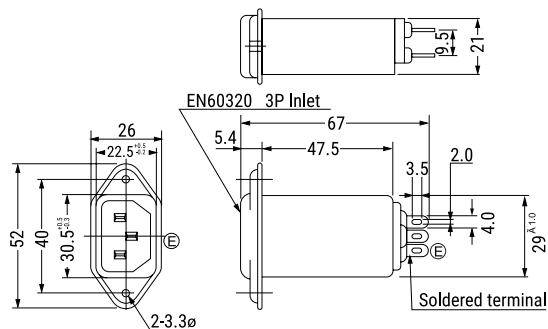

Dimensions	
L	67mm NOM
W	52mm NOM
H	26mm NOM

Packaging Specifications	
Packaging:	Tray, Box
Packaging Quantity:	25
Weight:	55 g

General Information	
Series:	GL
Style:	Metal Box
Description:	Noise Filters
RoHS:	Yes
Qualifications:	UL, CSA, TUV
Miscellaneous:	30 K Self-Temperature Rise Max.

Specifications	
Voltage AC:	250 VAC
Voltage:	250 VDC, 1500 VAC Withstanding Voltage 1 Min. Line to Ground
Rated Current:	6 A (AC/DC)
Ripple Current:	6 A (AC/DC)
Rated Temperature:	55°C
Temperature Range:	-25/+55°C
Leakage Current:	0.5 mA MAX (250 V 60 Hz)
Resistance:	300 MOhms MIN Insulation 500 VDC 1 Min. Line To Ground

Statements of suitability for certain applications are based on our knowledge of typical operating conditions for such applications, but are not intended to constitute - and we specifically disclaim - any warranty concerning suitability for a specific customer application or use. This Information is intended for use only by customers who have the requisite experience and capability to determine the correct products for their application. Any technical advice inferred from this Information or otherwise provided by us with reference to the use of our products is given gratis, and we assume no obligation or liability for the advice given or results obtained.