

F863, Film, Metallized Polypropylene, Automotive Safety, 0.1 uF, 10%, 310 VAC (X2), 110°C, Lead Spacing = 15mm

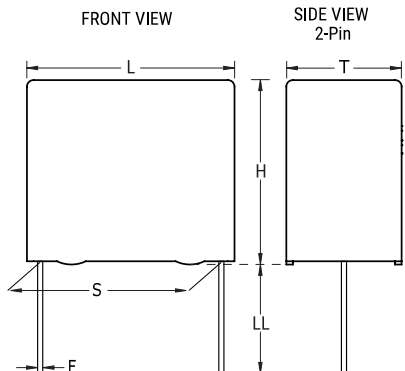

Dimensions

L	18mm +0.3/-0.5mm
H	11mm +0.1/-0.5mm
T	5mm +0.2/-0.5mm
S	15mm +/-0.4mm
LL	30mm +5mm
F	0.6mm +/-0.05mm

Packaging Specifications

Packaging:	Bulk, Bag
Packaging Quantity:	1000

General Information

Series:	F863
Dielectric:	Metallized Polypropylene
Style:	Radial
Features:	MKP EMI, Automotive Grade, Harsh Environmental Conditions
RoHS:	Yes
Lead:	Wire Leads
Safety Class:	X2
Qualifications:	ENEC, UL, cUL, CQC, AEC-Q200
AEC-Q200:	Yes
Shelf Life:	104 Weeks

Specifications

Capacitance:	0.1 uF
Capacitance Tolerance:	10%
Voltage AC:	310 VAC (X2)
Temperature Range:	-40/+110°C
Rated Temperature:	110°C
Dissipation Factor:	0.3% 1kHz
Insulation Resistance:	30 GOhms
Max dV/dt:	400 V/us