

EXV, Aluminum Electrolytic, 22 uF, 20%, 50 VDC, -55/+105°C

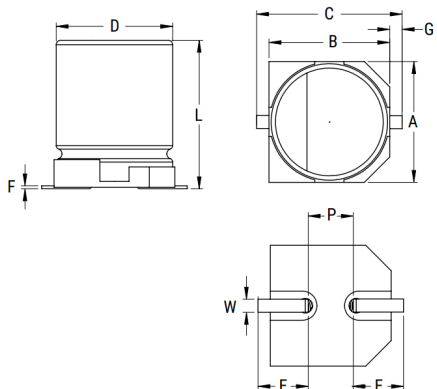

General Information	
Series:	EXV
Dielectric:	Aluminum Electrolytic
Style:	SMD Can
Description:	Surface Mount, Aluminum Electrolytic
Features:	Ultra Low Impedance
RoHS:	Yes
Lead:	V-Chip
AEC-Q200:	No

Dimensions	
D	6.3mm +/-0.5mm
L	7.7mm +/-0.3mm
W	0.65mm +/-0.1mm
F	0.3mm MAX
A	6.6mm +/-0.2mm
B	6.6mm +/-0.2mm
C	7.8mm MAX
E	2.6mm +/-0.2mm
G	0.35mm +0.15/-0.2mm
P	1.8mm +/-0.2mm

Specifications	
Capacitance:	22 uF
Capacitance Tolerance:	20%
Voltage DC:	50 VDC, 63 VDC (Surge)
Temperature Range:	-55/+105°C
Rated Temperature:	105°C
Life:	3000 Hrs
Dissipation Factor:	12%
Resistance:	1.3 Ohms (100kHz)
Ripple Current:	161 mAmps (120Hz), 322 mAmps (120Hz 85C), 230 mAmps (100kHz)
Leakage Current:	11 uA (2min 20°C)
Impedance Ratio at -25C:	2
Impedance Ratio at -40C:	3
High Temperature Solder:	Yes

Packaging Specifications	
Packaging:	T&R, 380mm
Packaging Quantity:	1000

Statements of suitability for certain applications are based on our knowledge of typical operating conditions for such applications, but are not intended to constitute - and we specifically disclaim - any warranty concerning suitability for a specific customer application or use. This Information is intended for use only by customers who have the requisite experience and capability to determine the correct products for their application. Any technical advice inferred from this Information or otherwise provided by us with reference to the use of our products is given gratis, and we assume no obligation or liability for the advice given or results obtained.