

ESL, Aluminum Electrolytic, 10 uF, 20%, 200 VDC, -40/+105°C, Lead Spacing = 3.5mm

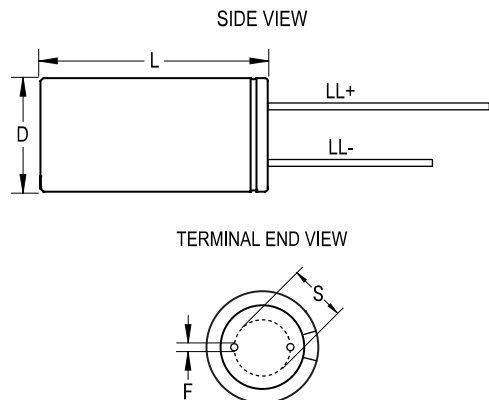

Dimensions	
D	8mm +/-0.5mm
L	12mm +2.0mm
S	3.5mm +/-0.5mm
LL Negative	15mm MIN
LL Positive	20mm MIN
F	0.6mm NOM

Packaging Specifications	
Packaging:	Bulk, Bag
Packaging Quantity:	6000

General Information	
Series:	ESL
Dielectric:	Aluminum Electrolytic
Description:	Single Ended Aluminum Electrolytic
RoHS:	Yes
Lead:	Wire Leads
AEC-Q200:	No

Specifications	
Capacitance:	10 uF
Capacitance Tolerance:	20%
Voltage DC:	200 VDC, 250 VDC (Surge)
Temperature Range:	-40/+105°C
Rated Temperature:	105°C
Life:	10000 Hrs
Dissipation Factor:	15%
Resistance:	3.65 Ohms (100kHz 20C)
Ripple Current:	175 mAmps (100kHz 105C)
Leakage Current:	50 uA (2min 20°C)
Impedance Ratio at -40C:	6

Statements of suitability for certain applications are based on our knowledge of typical operating conditions for such applications, but are not intended to constitute - and we specifically disclaim - any warranty concerning suitability for a specific customer application or use. This Information is intended for use only by customers who have the requisite experience and capability to determine the correct products for their application. Any technical advice inferred from this Information or otherwise provided by us with reference to the use of our products is given gratis, and we assume no obligation or liability for the advice given or results obtained.