

ELG, Aluminum Electrolytic, 2,200 uF, 20%, 63 VDC, -40/+105°C

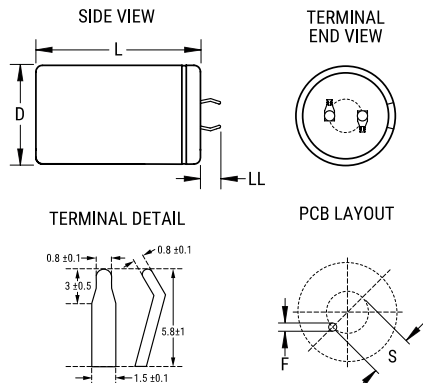

Dimensions

D	22mm +1mm
L	35mm +2mm
S	10mm +/-0.5mm
LL	5.8mm +/-1mm
F	1.5mm +/-0.1mm

Packaging Specifications

Packaging:	Bulk, Bag
Packaging Quantity:	400

General Information

Series:	ELG
Dielectric:	Aluminum Electrolytic
Description:	Snap-In, Aluminum Electrolytic
RoHS:	Yes
Lead:	2 Pin
AEC-Q200:	No

Specifications

Capacitance:	2,200 uF
Capacitance Tolerance:	20%
Voltage DC:	63 VDC, 79 VDC (Surge)
Temperature Range:	-40/+105°C
Rated Temperature:	105°C
Life:	2000 Hrs
Dissipation Factor:	25% 120Hz 20C
Ripple Current:	1700 mAmps (120Hz)
Leakage Current:	2800 uA (5min 20°C)
Impedance Ratio at -25C:	2
Impedance Ratio at -40C:	6