

KONNEKT KC-Link, Ceramic, 0.88 uF, 10%, 500 VDC, COG, 4-Chip Low Loss Orientation.

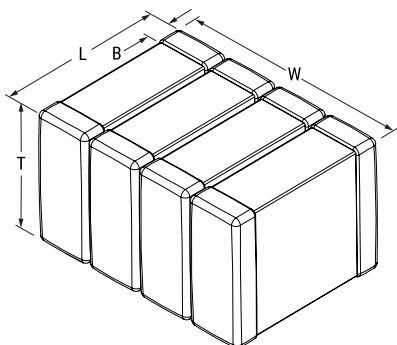

Dimensions	
L	9.3mm +/-0.6mm
W	10.3mm +/-0.8mm
T	10.2mm +/-0.4mm
B	1.27mm +/-0.4mm

Packaging Specifications	
Packaging:	T&R, 180mm
Packaging Quantity:	50

General Information	
Series:	KONNEKT KC-Link
Style:	KONNEKT
Description:	KC-LINK with KONNEKT, SMD, MLCC, Ultra-Stable, Class I
Features:	Ultra-Stable
RoHS:	Yes
Termination:	Tin
AEC-Q200:	No
Component Weight:	4.3 g
Notes:	4-Chip Low Loss Orientation.
Chip Size:	3640
MSL:	1

Specifications	
Capacitance:	0.88 uF
Measurement Condition:	1 kHz 1.0Vrms
Capacitance Tolerance:	10%
Voltage DC:	500 VDC
Dielectric Withstanding Voltage:	750 VDC
Temperature Range:	-55/+150°C
Temperature Coefficient:	COG
Capacitance Change with Reference to +25°C and 0 VDC Applied (TCC):	30 ppm/C, 1kHz 1.0Vrms
Dissipation Factor:	0.1% 1 kHz 1.0Vrms
Aging Rate:	0% Loss/Decade Hour
Insulation Resistance:	1.136 GOhms

Statements of suitability for certain applications are based on our knowledge of typical operating conditions for such applications, but are not intended to constitute - and we specifically disclaim - any warranty concerning suitability for a specific customer application or use. This Information is intended for use only by customers who have the requisite experience and capability to determine the correct products for their application. Any technical advice inferred from this Information or otherwise provided by us with reference to the use of our products is given gratis, and we assume no obligation or liability for the advice given or results obtained.