

C900AC SFTY X1-440 Y2-300, Ceramic, 4700 pF, 20%, 440 VAC (X1), 300 VAC (Y2), Y5V, Lead Spacing = 10mm

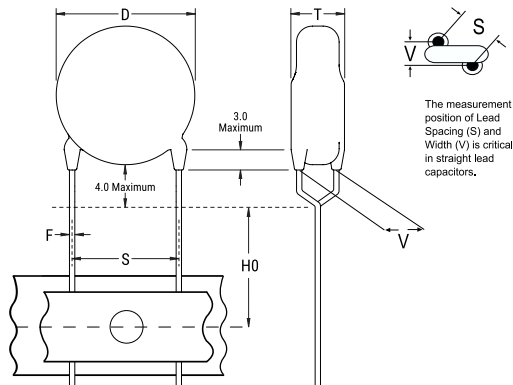

Dimensions

D	11mm MAX
T	5mm MAX
S	10mm +/-1mm
H0	18mm +2/-0mm
F	0.55mm +/-0.1mm

Packaging Specifications

Weight:	700 mg
Packaging:	Ammo
Packaging Quantity:	1000

General Information

Series:	C900AC SFTY X1-440 Y2-300
Style:	Radial Disc
RoHS:	Yes
Termination:	Tin
Failure Rate:	N/A
Qualifications:	UL, ENEC, VDE, CSA, CAN
AEC-Q200:	No
Halogen Free:	Yes

Specifications

Capacitance:	4700 pF
Capacitance Tolerance:	20%
Voltage AC:	440 VAC (X1), 300 VAC (Y2)
Dielectric Withstanding Voltage:	2600 VDC
Temperature Range:	-40/+125°C
Temperature Coefficient:	Y5V
Dissipation Factor:	5%
Insulation Resistance:	10 GOhms
Safety Class:	X1/Y2

Statements of suitability for certain applications are based on our knowledge of typical operating conditions for such applications, but are not intended to constitute - and we specifically disclaim - any warranty concerning suitability for a specific customer application or use. This Information is intended for use only by customers who have the requisite experience and capability to determine the correct products for their application. Any technical advice inferred from this Information or otherwise provided by us with reference to the use of our products is given gratis, and we assume no obligation or liability for the advice given or results obtained.