

C4C, Film, Metallized Polypropylene, Power, 0.22 uF, 5%, 750 VAC, 3000 VDC, 70°C

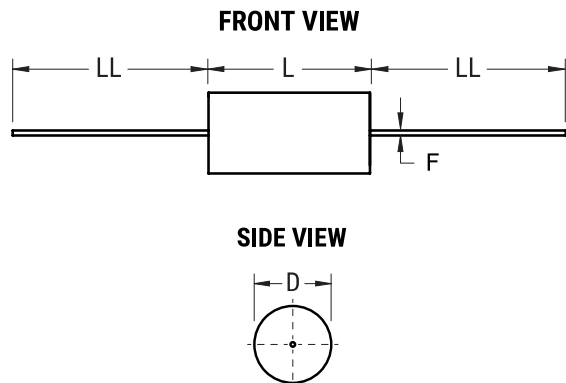

General Information	
Series:	C4C
Dielectric:	Metallized Polypropylene
Style:	Axial
RoHS:	Yes
Lead:	Wire Leads
AEC-Q200:	No
Component Weight:	45 g
Miscellaneous:	Polyester Tape & Resin Protection.

Dimensions	
D	31mm NOM
L	58mm NOM
LL	40mm +/-5mm
F	1.2mm NOM

Packaging Specifications	
Packaging:	Bulk, Bag
Packaging Quantity:	30

Specifications	
Capacitance:	0.22 uF
Capacitance Tolerance:	5%
Voltage AC:	750 VAC
Voltage DC:	3000 VDC
Temperature Range:	-40/+85°C
Rated Temperature:	70°C
Dissipation Factor:	0.05%
Max dV/dt:	750 V/us
Resistance:	9.5 mOhms (100kHz)
Ripple Current:	12 Amps (100kHz 70C), 165 Amps (Peak)

Statements of suitability for certain applications are based on our knowledge of typical operating conditions for such applications, but are not intended to constitute - and we specifically disclaim - any warranty concerning suitability for a specific customer application or use. This Information is intended for use only by customers who have the requisite experience and capability to determine the correct products for their application. Any technical advice inferred from this Information or otherwise provided by us with reference to the use of our products is given gratis, and we assume no obligation or liability for the advice given or results obtained.