

KEMET Part Number: C315C153K5R5TA7303
(C315C153K5R5TATR)

KEMET
a YAGEO company

GoldMax 300 Comm X7R, Ceramic, 0.015 uF, 10%, 50 VDC, X7R, GoldMax, Commercial Standard, Lead Spacing = 2.54mm

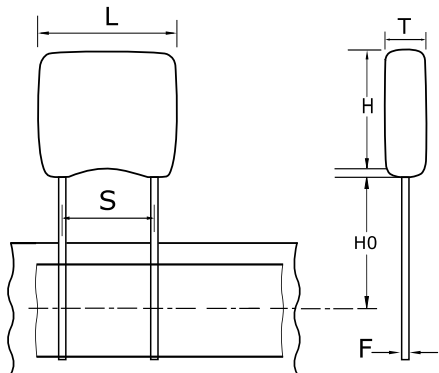

Dimensions

Dimension	Value
L	3.81mm MAX
H	3.14mm MAX
T	2.54mm MAX
S	2.54mm +/-0.78mm
H0	18mm MIN
F	0.51mm +0.1/-0.025mm

Packaging Specifications

Packaging:	T&R, 305mm
Packaging Quantity:	2500

General Information

Series:	GoldMax 300 Comm X7R
Style:	Radial
Description:	GoldMax, Commercial Standard
RoHS:	Yes
Termination:	Tin
Failure Rate:	N/A
AEC-Q200:	No
Halogen Free:	Yes

Specifications

Capacitance:	0.015 uF
Measurement Condition:	1 kHz 1.0Vrms
Capacitance Tolerance:	10%
Voltage DC:	50 VDC
Dielectric Withstanding Voltage:	125 VDC
Temperature Range:	-55/+125°C
Temperature Coefficient:	X7R
Capacitance Change with Reference to +25°C and 0 VDC Applied (TCC):	0.15, 1kHz 1.0Vrms
Dissipation Factor:	2.5% 1 kHz 1.0Vrms
Aging Rate:	3% Loss/Decade Hour
Insulation Resistance:	66.67 GOhms

Statements of suitability for certain applications are based on our knowledge of typical operating conditions for such applications, but are not intended to constitute - and we specifically disclaim - any warranty concerning suitability for a specific customer application or use. This Information is intended for use only by customers who have the requisite experience and capability to determine the correct products for their application. Any technical advice inferred from this Information or otherwise provided by us with reference to the use of our products is given gratis, and we assume no obligation or liability for the advice given or results obtained.

KEMET
a YAGEO company