

KEMET Part Number: ALC70C752FP200
(A546JW752M200C)

ALC70, Aluminum Electrolytic, 7,500 uF, 20%, 200 VDC, -40/+85°C

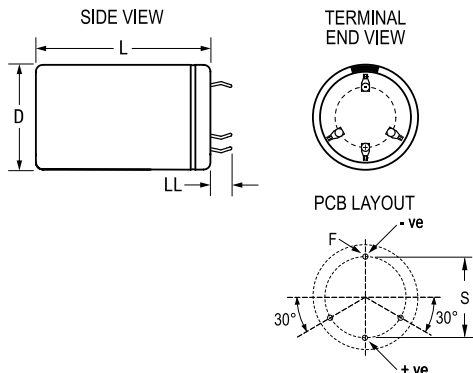

General Information	
Series:	ALC70
Dielectric:	Aluminum Electrolytic
Description:	Snap-In, Aluminum Electrolytic
RoHS:	Yes
Lead:	4 Pin
AEC-Q200:	No
Halogen Free:	Yes
Notes:	Dimensions D And L Include Slewing.
Shelf Life:	156 Weeks

Dimensions	
D	45mm +1mm
L	105mm +/-2mm
S	22.5mm +/-0.1mm
LL	6.3mm +/-1mm
F	2mm +/-0.1mm

Specifications	
Capacitance:	7,500 uF
Capacitance Tolerance:	20%
Voltage DC:	200 VDC, 230 VDC (Surge)
Temperature Range:	-40/+85°C
Rated Temperature:	85°C
Life:	18000 Hrs (Rated Voltage And Ripple Current At 85C), 29000 Hrs (Rated Voltage at 85C)
Resistance:	33.65 mOhms (100Hz 20C), 22.37 mOhms (10kHz 20C)
Ripple Current:	10.2 Amps (100Hz 85C), 15.97 Amps (10kHz 85C)
Leakage Current:	6000 uA (5min 20°C)

Packaging Specifications	
Weight:	225 g
Slewing:	Yes
Packaging:	Bulk, Bag