

KEMET Part Number: ALC70C682KP250
(A546KW682M250C)

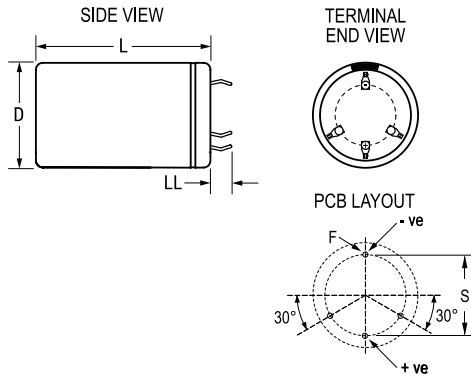

ALC70, Aluminum Electrolytic, 6,800 uF, 20%, 250 VDC, -40/+85°C



General Information	
Series:	ALC70
Dielectric:	Aluminum Electrolytic
Description:	Snap-In, Aluminum Electrolytic
RoHS:	Yes
Lead:	4 Pin
AEC-Q200:	No
Halogen Free:	Yes
Notes:	Dimensions D And L Include Slewing.
Shelf Life:	156 Weeks

Dimensions	
D	50mm +1mm
L	105mm +/-2mm
S	22.5mm +/-0.1mm
LL	6.3mm +/-1mm
F	2mm +/-0.1mm

Specifications	
Capacitance:	6,800 uF
Capacitance Tolerance:	20%
Voltage DC:	250 VDC, 288 VDC (Surge)
Temperature Range:	-40/+85°C
Rated Temperature:	85°C
Life:	18000 Hrs (Rated Voltage And Ripple Current At 85C), 29000 Hrs (Rated Voltage at 85C)
Resistance:	32.18 mOhms (100Hz 20C), 20.42 mOhms (10kHz 20C)
Ripple Current:	10.63 Amps (100Hz 85C), 16.84 Amps (10kHz 85C)
Leakage Current:	6000 uA (5min 20°C)

Packaging Specifications	
Weight:	310 g
Slewing:	Yes
Packaging:	Bulk, Bag

Statements of suitability for certain applications are based on our knowledge of typical operating conditions for such applications, but are not intended to constitute - and we specifically disclaim - any warranty concerning suitability for a specific customer application or use. This Information is intended for use only by customers who have the requisite experience and capability to determine the correct products for their application. Any technical advice inferred from this Information or otherwise provided by us with reference to the use of our products is given gratis, and we assume no obligation or liability for the advice given or results obtained.

